

# Installation steps

Before use this equipment, please read this guide for installing equipment quickly.

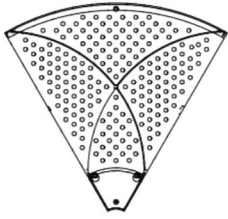

Reflector  
(Qty.6x2pcs)

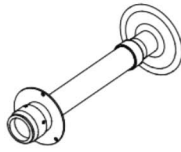

Feedhorn  
(Qty.2pcs)



Connector  
(Qty.2pcs)

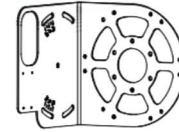

Bracket with hanger  
(Qty.2pcs)

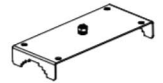

U-groove  
(Qty.2pcs)

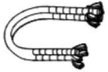

U Bolt  
(Qty.4pcs)



Cross hex wrench  
(Qty.1pc)



Hexagon socket screws  
Locking the Feedhorn,  
fixing the equipment  
(M5 Qty.3x2pcs)



Screws (for bracket)  
(M5 Qty.12x2pcs)



Screws  
Assemble the reflector  
Assemble the coupler  
(M5 Qty.12x2pcs)

## Bracket Installation

1. Assemble the 6 pieces of Reflector on the Bracket with hanger, and each Reflector is fixed with 2 M6 screws.
2. Use M5 screws to fix the Reflector, each Reflector is fixed with 2 M5 screws.
3. ① Remove connector  
② Install the feedhorn on the antenna and fix it with 3 M5 screws.

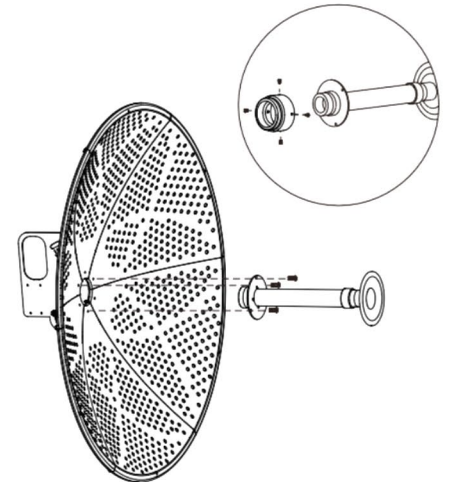
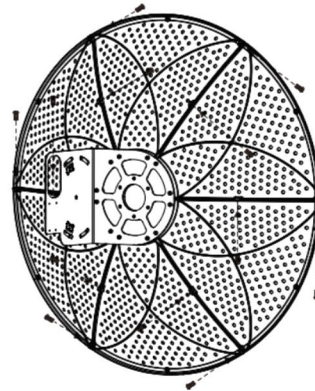
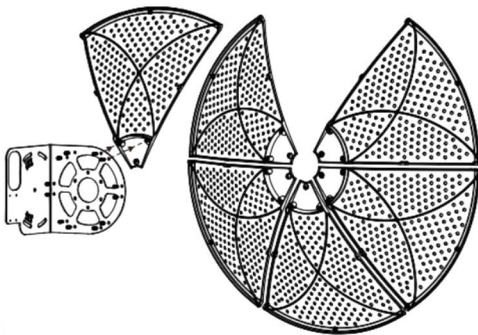

4. Screw the device clockwise into the connector and the holder, and then fix the device with 4 M4 hexagon socket screws.
5. Fix the U-groove to the Bracket with nuts by M8 wrench.
6. Remove the nut on the U-Bolt, select the appropriate position of the antenna to adjust the antenna angle, lock the nut to the U-Bolt, fix the antenna, and complete the installation.  
Note: The mounting assembly can accommodate a  $\varnothing$  30 - 80mm pole.

