

0.6 m | 2 ft Standard Performance Parabolic Reflector Antenna, Single-polarized, 10.7-11.7GHz

SP2-11



The SP Standard Performance Series by RadioWaves offers a full line of cost effective standard performance parabolic antennas engineered to deliver reliable radio links. Designed for both unlicensed and licensed band applications, RadioWaves field-proven pre-assembled SP antennas and robust pole-mounts ensure “set and forget” installation with minimal post-installation maintenance. If it’s rugged, it must be RadioWaves!

FEATURES AND BENEFITS

- Standard Performance Parabolic Antennas – Excellent performance for a wide range of licensed and unlicensed applications
- Fully Preassembled at the Factory – Simplifies installation on site and guarantees “factory-tested” quality

SPECIFICATIONS

General

Antenna Type	Standard Performance Parabolic Reflector Antenna
Size, nominal	2 ft 0.6 m
Polarization	Single

Standard RF Connector Type	CPR90G
Standard RF Connector Suffix	RS (append suffix to model number)

Electrical

Operating Frequency Band	10.7 - 11.7 GHz
Half Power Beamwidth, Horizontal	3.4 degrees
Half Power Beamwidth, Vertical	3.4 degrees
Cross-Polarization Discrimination	30 dB
Front to Back Ratio (F/B)	40 dB

Gain, Low Frequency	34.3 dBi
Gain, Mid Frequency	34.6 dBi
Gain, High Frequency	34.9 dBi
VSWR	1.37:1
Return Loss	-16.1 dB

Mechanical

Fine Azimuth Adjustment	+/- 10 degrees	
Fine Elevation Adjustment	+/- 30 degrees	
Mounting Pipe Diameter, Min	2 inch 5.08 cm	
Mounting Pipe Diameter, Max	4.5 inch 11.4 cm	
Net Weight	22 lbs 9.9 kg	26 lbs 11.7 Kg with RD radome
Wind Velocity Operational	90 mph 145 km/h	
Wind Velocity Survival Rating	125 mph 201 km/h	

Mechanical Configuration	SP2	
Axial Force (FA)	222 lbs 988 N	122 lbs 543 Nm with RD radome
Side Force (FS)	14 lbs 62 N	24 lbs 107 Nm with RD radome
Twisting Moment (MT)	225 ft-lbs 305 Nm	194 lbs 263 Nm with RD radome
Operating Temperature Range	-40 to +60 C	
Max Pressure, PSIG, (if waveguide interface)	5	

Regulatory Compliance

FCC	undeclared
Industry Canada Compliance	undeclared

ETSI	302217 R1 C1
RoHS-compliant	Yes

Shipping Information

Package Type	Cardboard
Gross Weight	25 lbs 11.3 kg

Dimensions, L x W x H	28 x 8 x 28in 71 x 20 x 71 cm
Shipping Volume	3.63 cu ft 0.1 cu m

*Additional OEM interfaces and adapters may be available. Contact RadioWaves for a complete and current list of available adapters.

TECHNICAL DRAWINGS

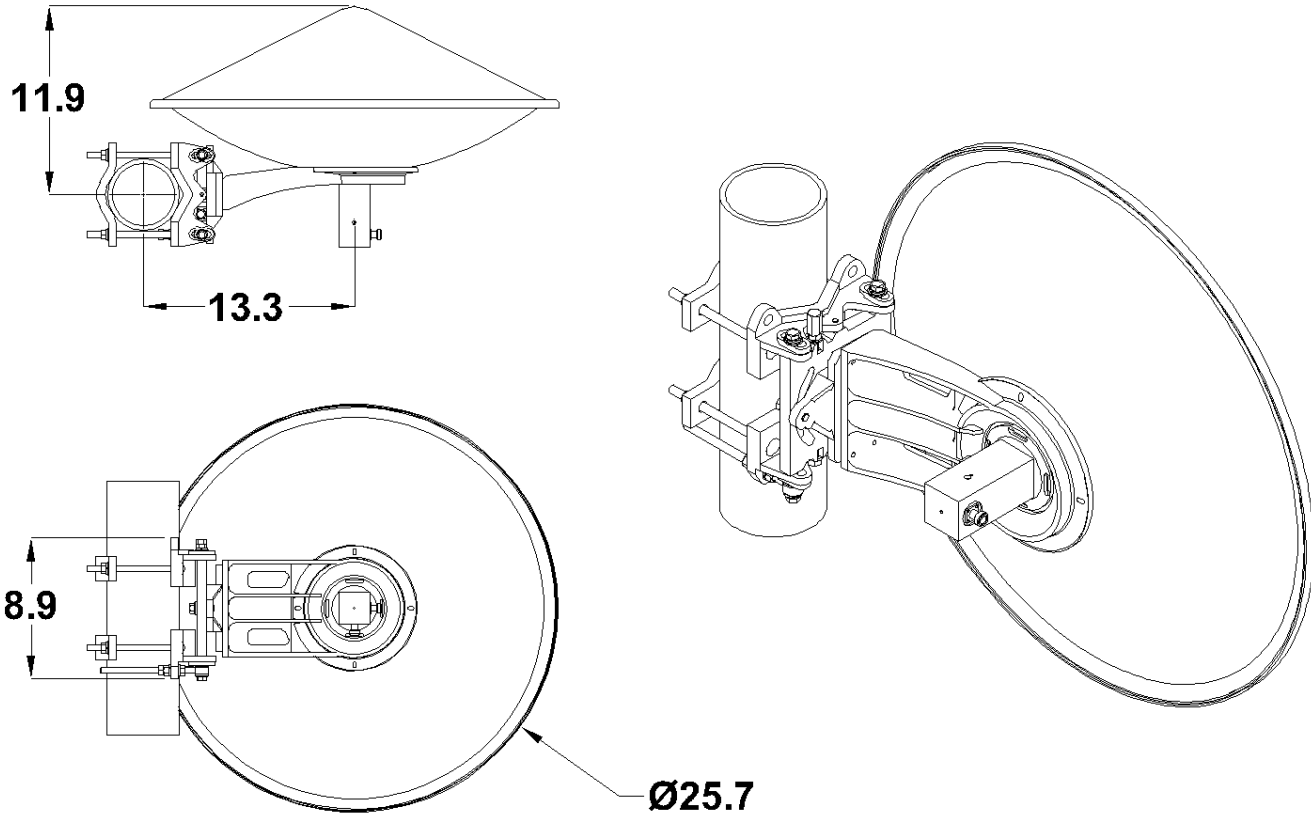

SP2