

0.9 m | 3 ft High Performance Parabolic Reflector Antenna, Single-polarized, 4.4-5GHz



HP3-4.7

The HP High Performance Series by RadioWaves offers a full line of high performance parabolic antennas engineered to provide ETSI class 2/3 radiation pattern performance as well as excellent gain. RadioWaves field-proven pre-assembled antennas and robust pole-mounts ensure “set and forget” installation with minimal post-installation maintenance. The included radome ensures robust and reliable performance under the most challenging conditions. If it’s rugged, it must be RadioWaves!

FEATURES AND BENEFITS

- High Performance ETSI Class 2/3* Parabolic Antennas – Excellent performance for a wide range of applications
- Fully Preassembled at the Factory – Simplifies installation on site and guarantees “factory-tested” quality

*ETSI Class depends on frequency band

SPECIFICATIONS

General

Antenna Type	High Performance Parabolic Reflector Antenna
Size, nominal	3 ft 0.9 m
Polarization	Single

Standard RF Connector Type	N-Female
Standard RF Connector Suffix	NS (append suffix to model number)

Electrical

Operating Frequency Band	4.4 - 5 GHz
Half Power Beamwidth, Horizontal	4.7 degrees
Half Power Beamwidth, Vertical	4.7 degrees
Cross-Polarization Discrimination	30 dB
Front to Back Ratio (F/B)	52 dB

Gain, Low Frequency	29.2 dBi
Gain, Mid Frequency	29.8 dBi
Gain, High Frequency	30.3 dBi
VSWR	1.5:1
Return Loss	-14 dB

Mechanical

Fine Azimuth Adjustment	+/- 10 degrees
Fine Elevation Adjustment	+/- 25 degrees
Mounting Pipe Diameter, Min	4.5 inch 11.4 cm
Mounting Pipe Diameter, Max	4.5 inch 11.4 cm
Net Weight	50 lbs 12.3 kg
Wind Velocity Operational	90 mph 145 km/h
Wind Velocity Survival Rating	125 mph 201 km/h

Mechanical Configuration	HP3-LoFreq
Axial Force (FA)	403 lbs 1972 N
Side Force (FS)	200 lbs 890 N
Twisting Moment (MT)	344 ft-lbs 466 Nm
Operating Temperature Range	-40 to +60 C
Max Pressure, PSIG, (if waveguide interface)	5

Regulatory Compliance

FCC	undeclared
Industry Canada Compliance	undeclared

ETSI	undeclared
RoHS-compliant	Yes

Shipping Information

Package Type	Wood Crate
Gross Weight	143 lbs 69.8 kg

Dimensions, L x W x H	47 x 28 x 48in 119 x 71 x 122 cm
Shipping Volume	36.56 cu ft 1.04 cu m

*Additional OEM interfaces and adapters may be available. Contact RadioWaves for a complete and current list of available adapters.

TECHNICAL DRAWINGS

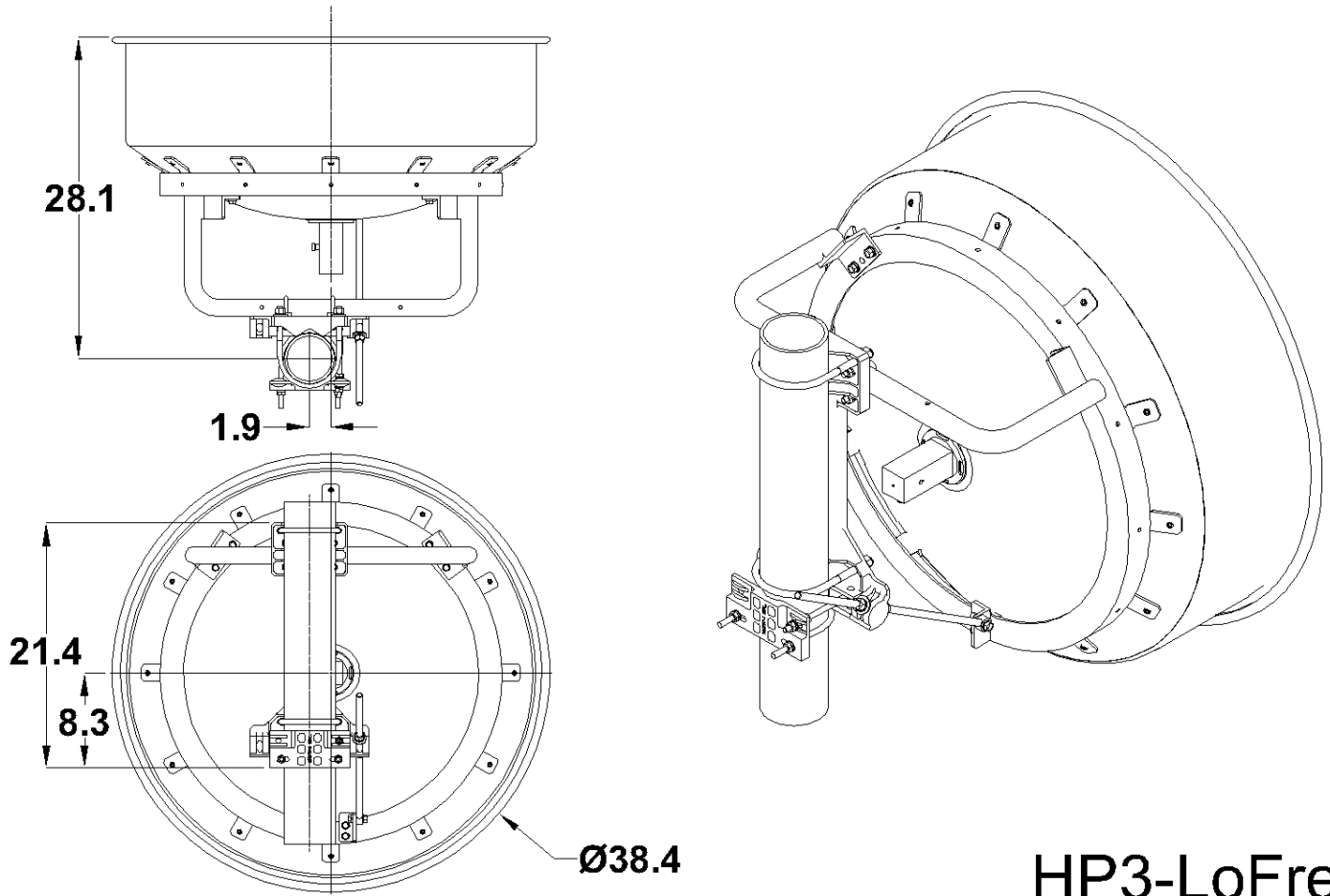

HP3-LoFreq