

0.9 m | 3 ft Standard Performance Parabolic Reflector
Antenna, Dual-polarized, 1.7-1.9GHz

SPD3-1.8



The SP Standard Performance Series by RadioWaves offers a full line of cost effective standard performance parabolic antennas engineered to deliver reliable radio links. Designed for both unlicensed and licensed band applications, RadioWaves field-proven pre-assembled SP antennas and robust pole-mounts ensure “set and forget” installation with minimal post-installation maintenance. If it’s rugged, it must be RadioWaves!

FEATURES AND BENEFITS

- Standard Performance Parabolic Antennas – Excellent performance for a wide range of licensed and unlicensed applications
- Fully Preassembled at the Factory – Simplifies installation on site and guarantees “factory-tested” quality

SPECIFICATIONS

General

Antenna Type	Standard Performance Parabolic Reflector Antenna
Size, nominal	3 ft 0.9 m
Polarization	Dual

Standard RF Connector Type	N-Female
Standard RF Connector Suffix	NS (append suffix to model number)

Electrical

Operating Frequency Band	1.7 - 1.9 GHz
Half Power Beamwidth, Horizontal	9.5 degrees
Half Power Beamwidth, Vertical	9.5 degrees
Cross-Polarization Discrimination	30 dB
Front to Back Ratio (F/B)	28 dB

Gain, Low Frequency	20.9 dBi
Gain, Mid Frequency	21.4 dBi
Gain, High Frequency	21.9 dBi
VSWR	1.5:1
Return Loss	-14 dB

Mechanical

Fine Azimuth Adjustment	+/- 10 degrees	
Fine Elevation Adjustment	+/- 25 degrees	
Mounting Pipe Diameter, Min	4.5 inch 11.4 cm	
Mounting Pipe Diameter, Max	4.5 inch 11.4 cm	
Net Weight	35 lbs 15.8 kg	43 lbs 19.4 Kg with RD radome
Wind Velocity Operational	90 mph 145 km/h	
Wind Velocity Survival Rating	125 mph 201 km/h	

Mechanical Configuration	SP3	
Axial Force (FA)	492 lbs 2189 N	271 lbs 1206 Nm with RD radome
Side Force (FS)	40 lbs 178 N	64 lbs 285 Nm with RD radome
Twisting Moment (MT)	545 ft-lbs 739 Nm	394 lbs 534 Nm with RD radome
Operating Temperature Range	-40 to +60 C	
Max Pressure, PSIG, (if waveguide interface)	na	

Regulatory Compliance

FCC	undeclared
Industry Canada Compliance	undeclared

ETSI	undeclared
RoHS-compliant	Yes

Shipping Information

Package Type	Wood Crate
Gross Weight	78 lbs 35.3 kg

Dimensions, L x W x H	40 x 17 x 44in 101 x 43 x 140 cm
Shipping Volume	17.31 cu ft 0.49 cu m

*Additional OEM interfaces and adapters may be available. Contact RadioWaves for a complete and current list of available adapters.

TECHNICAL DRAWINGS

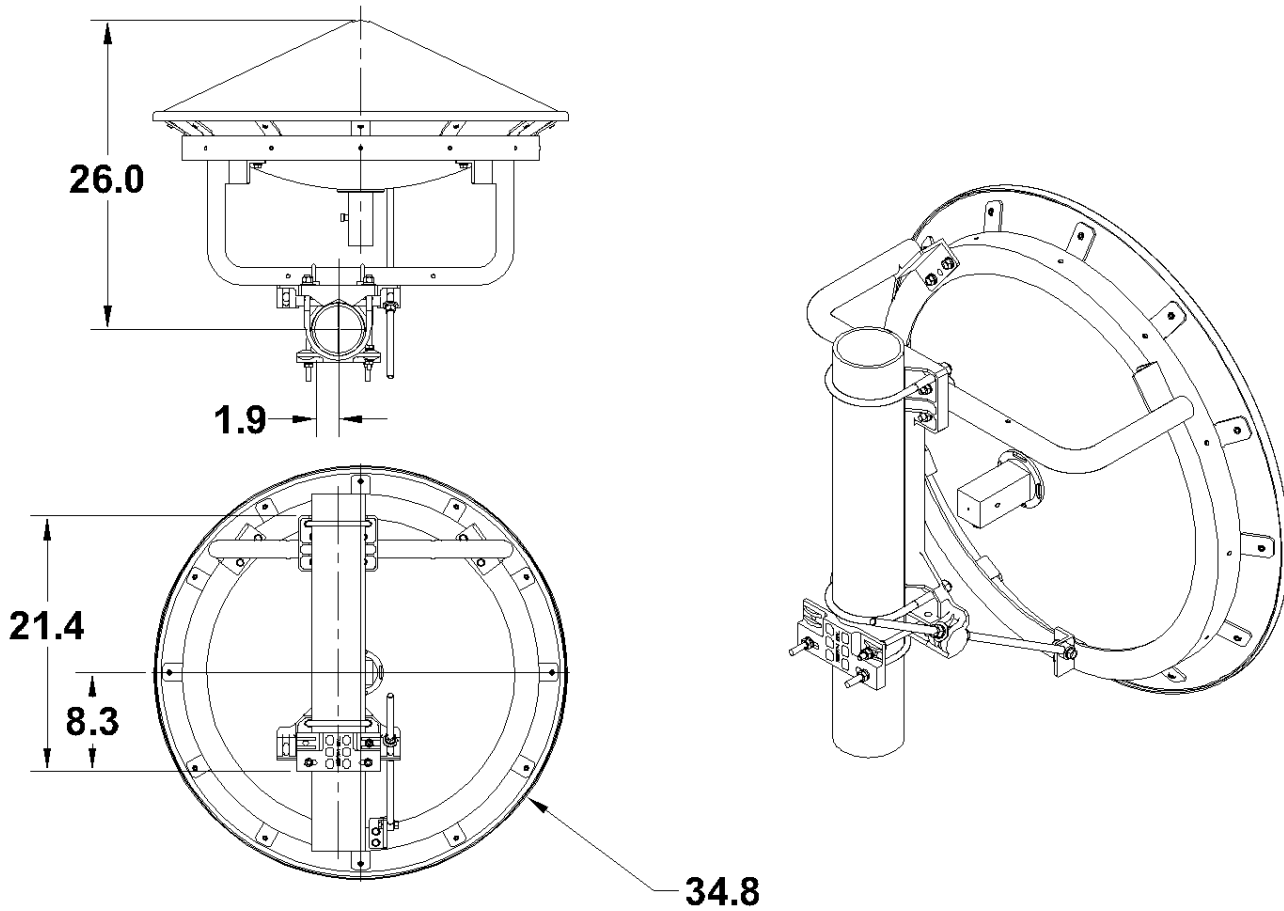

SP3