

1.8 m | 6 ft Standard Performance Parabolic Reflector Antenna, Single-polarized, 1.7-1.9GHz



SP6-1.8

The SP Standard Performance Series by RadioWaves offers a full line of cost effective standard performance parabolic antennas engineered to deliver reliable radio links. Designed for both unlicensed and licensed band applications, RadioWaves field-proven pre-assembled SP antennas and robust pole-mounts ensure “set and forget” installation with minimal post-installation maintenance. If it’s rugged, it must be RadioWaves!

FEATURES AND BENEFITS

- Standard Performance Parabolic Antennas – Excellent performance for a wide range of licensed and unlicensed applications
- Fully Preassembled at the Factory – Simplifies installation on site and guarantees “factory-tested” quality

SPECIFICATIONS

General

Antenna Type	Standard Performance Parabolic Reflector Antenna
Size, nominal	6 ft 1.8 m
Polarization	Single

Standard RF Connector Type	N-Female
Standard RF Connector Suffix	NS (append suffix to model number)

Electrical

Operating Frequency Band	1.7 - 1.9 GHz
Half Power Beamwidth, Horizontal	6.2 degrees
Half Power Beamwidth, Vertical	6.2 degrees
Cross-Polarization Discrimination	30 dB
Front to Back Ratio (F/B)	36 dB

Gain, Low Frequency	27.1 dBi
Gain, Mid Frequency	27.6 dBi
Gain, High Frequency	28.1 dBi
VSWR	1.5:1
Return Loss	-14 dB

Mechanical

Fine Azimuth Adjustment	+/- 10 degrees	
Fine Elevation Adjustment	+/- 25 degrees	
Mounting Pipe Diameter, Min	4.5 inch 11.4 cm	
Mounting Pipe Diameter, Max	4.5 inch 11.4 cm	
Net Weight	95 lbs 42.8 kg	125 lbs 56.3 Kg with RD radome
Wind Velocity Operational	90 mph 145 km/h	
Wind Velocity Survival Rating	125 mph 201 km/h	

Mechanical Configuration	SP6	
Axial Force (FA)	1768 lbs 7865 N	973 lbs 4329 Nm with RD radome
Side Force (FS)	98 lbs 436 N	162 lbs 721 Nm with RD radome
Twisting Moment (MT)	2270 ft-lbs 3077 Nm	2100 lbs 2847 Nm with RD radome
Operating Temperature Range	-40 to +60 C	
Max Pressure, PSIG, (if waveguide interface)	5	

Regulatory Compliance

FCC	undeclared
Industry Canada Compliance	undeclared

ETSI	undeclared
RoHS-compliant	Yes

Shipping Information

Package Type	Wood Crate
Gross Weight	222 lbs 100.7 kg

Dimensions, L x W x H	77 x 20 x 80in 195 x 501 x 203 cm
Shipping Volume	71.3 cu ft 2.02 cu m

*Additional OEM interfaces and adapters may be available. Contact RadioWaves for a complete and current list of available adapters.

TECHNICAL DRAWINGS

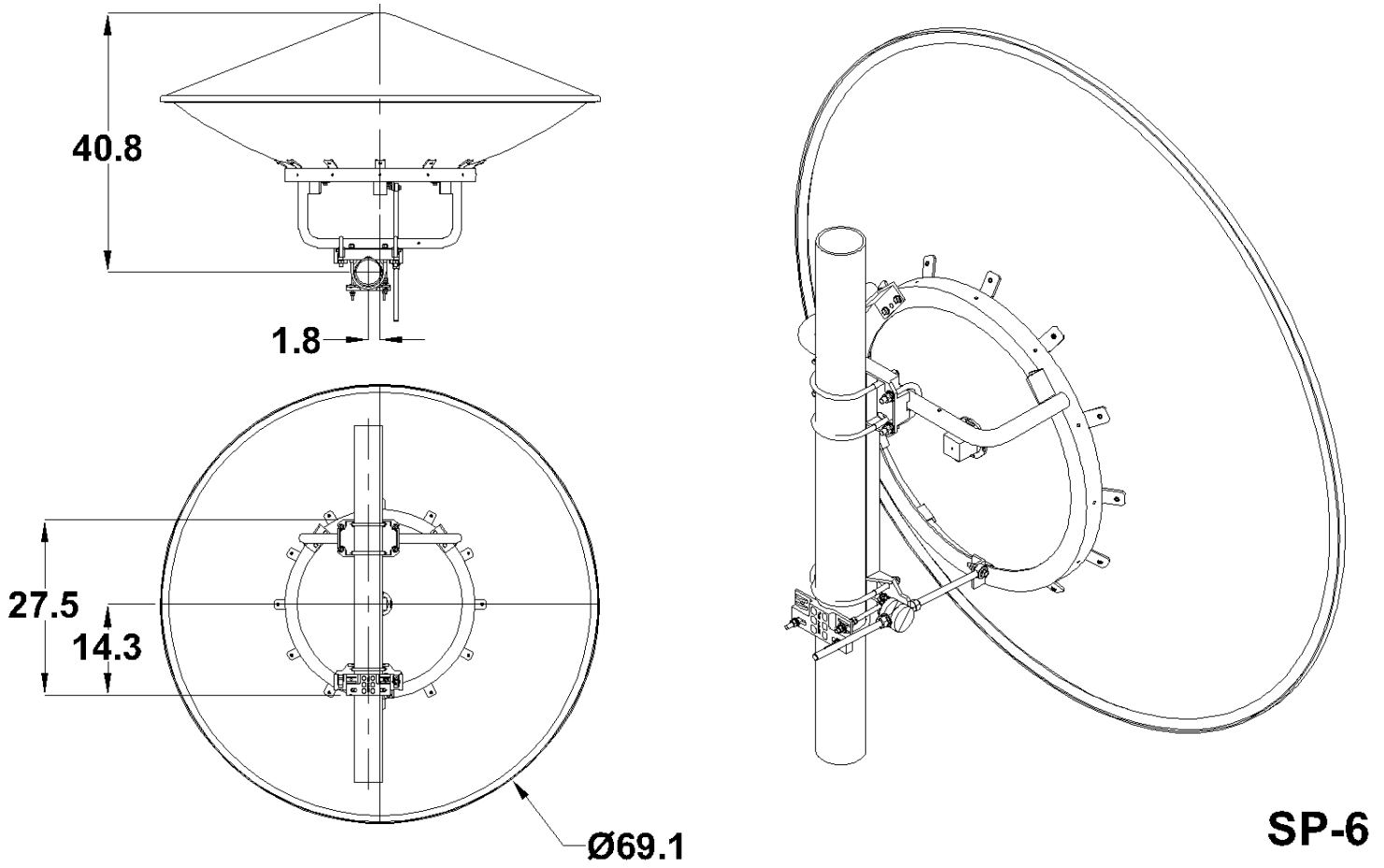

SP-6