

Accessory: Blanking Plate, used with Waveguide interface, omt's, couplers

104475-90CPR

SPECIFICATIONS

General

Item	Accessory: Blanking Plate
Used With	Waveguide interface, omt's, couplers

*Additional OEM interfaces and adapters may be available. Contact RadioWaves for a complete and current list of available adapters.

Mechanical

Net Weight	consult factory	Operating Temperature Range	-40 to +60 C
Mechanical Configuration	BPLATE		

Regulatory Compliance

RoHS-compliant	Yes
----------------	-----

Shipping Information

Package Type	consult factory	Dimensions, L x W x H	consult factory
Gross Weight	consult factory	Shipping Volume	consult factory

TECHNICAL DRAWINGS

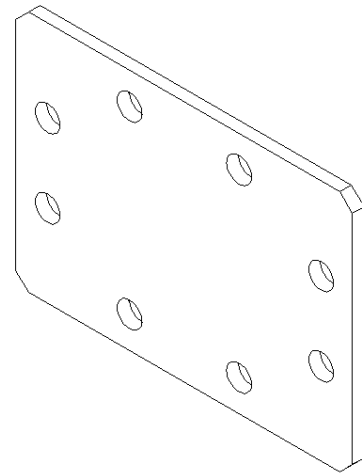
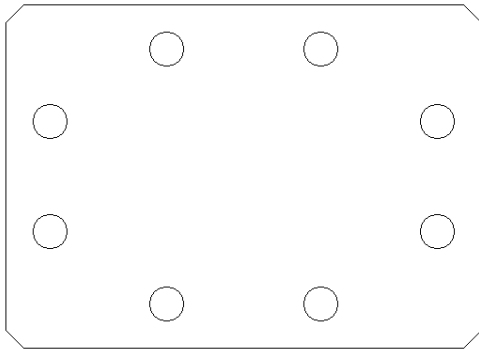

OL-BPlate